

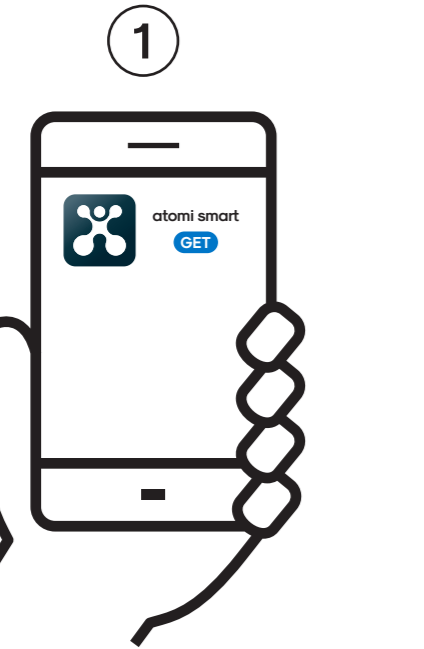

Let's get started!

Smart WiFi Ceiling Light

Quick Start Guide



Get the app

Download the atomi smart app from the App Store or Google Play.

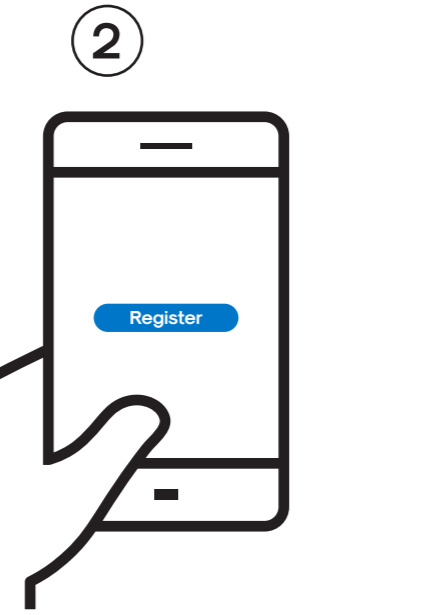

Register

Follow the on-screen instructions and register an account.

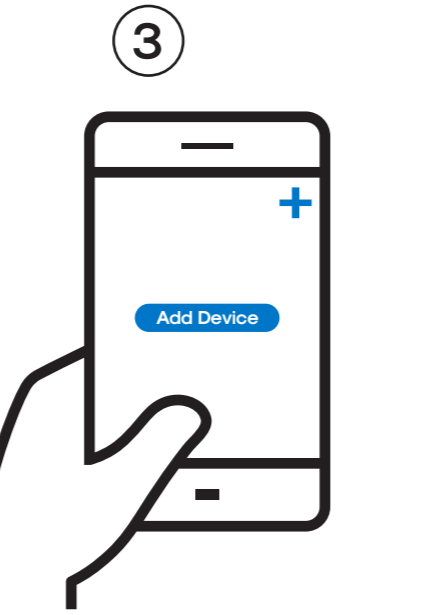

Add your smart device

Press "Add Device" or the "+" sign and choose the smart device to install from the device list.

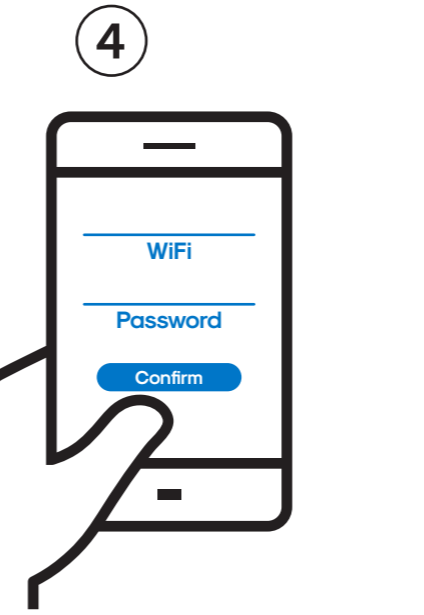

Select the right network

Enter your WiFi password and "Confirm".

Make sure you're connected to a 2.4GHz WiFi network (atomi Smart can't connect to 5GHz networks).

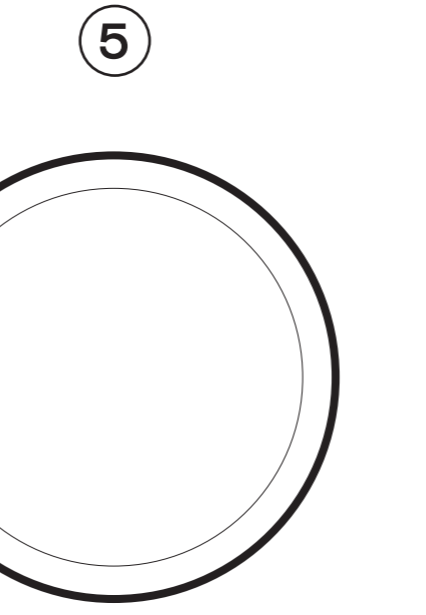

Turn on your smart device

And press "Continue" on the atomi smart app.

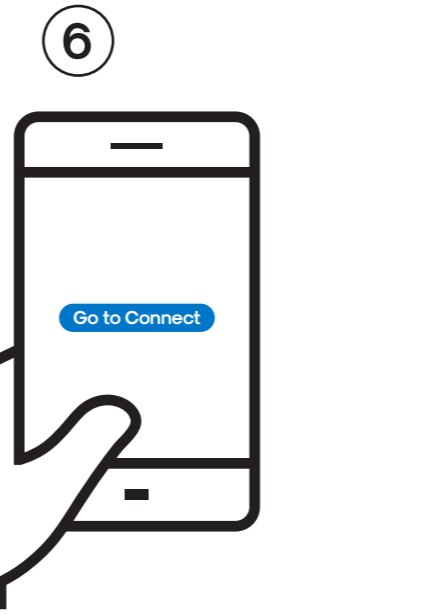

Connect to the network

Press "Go to Connect" and follow the instructions on the screen.



Connect your smart device

Select "atomi-smart-XXXX" on the network list to connect.

If you are not automatically directed to the WiFi list, go to SETTINGS on your smartphone and press WiFi.

Troubleshooting

Smart WiFi Ceiling Light

I can't find the atomi.smart.XXXX network in my WiFi list.

Make sure your atomi smart device is plugged in and the light is blinking quickly. If not, unplug your atomi smart device and plug it back in to reboot.

My WiFi network doesn't appear in the atomi smart app.

Use your smartphone to confirm that you have at least two WiFi bars in the vicinity of your atomi smart device. If not, move your atomi smart device closer to your router. (The list will refresh every 10 seconds).

Cannot connect to my WiFi network.

Make sure that you have entered the correct WiFi password during setup. Check if there are problems with your internet connection. If the WiFi signal is too weak, reset your WiFi router and try again.

My atomi smart device appears as "Unavailable" in the app.

Refresh the device list.

My atomi smart app is frozen.

Force quit and re-launch the atomi smart app.

I just replaced my router.

To reset the WiFi without losing your atomi smart devices settings, hold down the power button and wait for the LED to change from amber to blinking white, then release. When the LED begins to alternate white and amber, follow steps 3-5 to associate your atomi smart device with your new network.

I'm still having trouble!

WiFi networks come in a lot of shapes and sizes with many quirks of their own. It doesn't mean your atomi smart device is malfunctioning. If problems persist, please try these steps, in this order:

1. Force quit and re-launch the atomi smart app. Check to see if this fixes the issue.
2. Unplug your atomi smart device and plug it back in. Check to see if this fixes the issue.
3. Unplug your router and plug it back in. Check to see if this fixes the issue.
4. Delete and reinstall the atomi smart app. Check to see if this fixes the issue.

For more troubleshooting tips go to www.atomismart.com/helpCeilingLight

Still can't connect? Need assistance?

Our friendly customer service team will work hard to put a smile back on your face. Here's how we can connect.



1-800-757-1440
Mon-Fri 9:00-5:00 EST (US)



or support@atomiusa.com

Wiring

Smart WiFi Ceiling Light

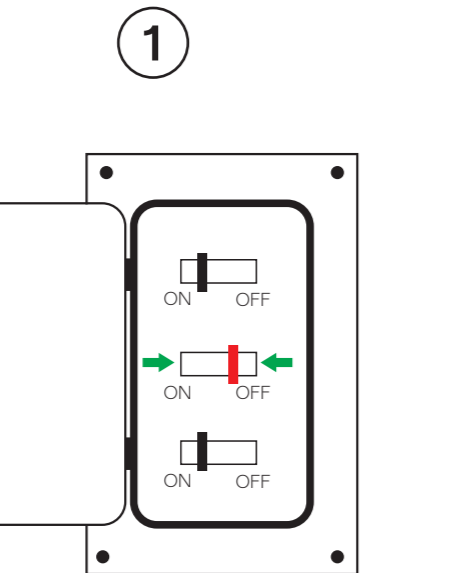

Turn off circuit breaker

Find your light's control in your circuit breaker and turn it off. Then make sure the power is off by flipping your switch a few times.

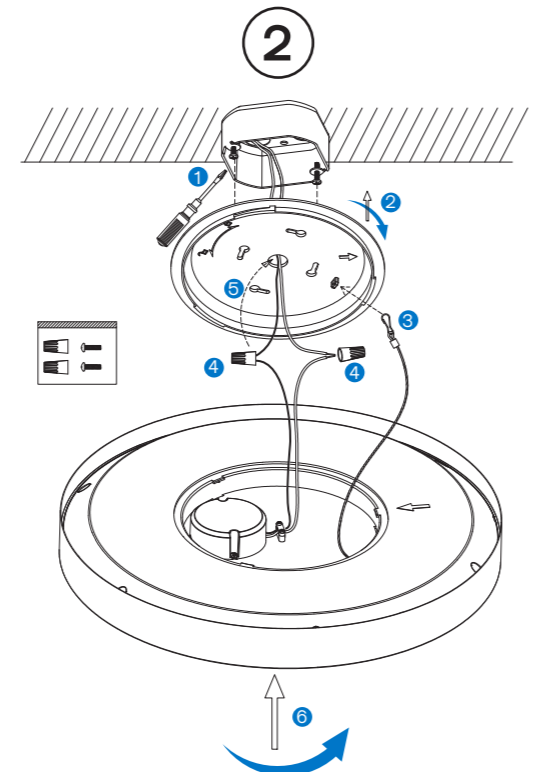

Follow the steps below:

1. Mount screws into the junction box, leaving the screws half an inch long.
2. Pass the power wire through the hole of the base, and turn it clockwise to lock the base in junction box.
3. Hang the wire rope at the hanging position of the mounting base to assist the installation.
4. Screw the LN wire L-L N-N with a screw cap.
5. Put wiring cap and wires back to the junction box.
6. Rotate the lamp body clockwise to fix the lamp on the base.

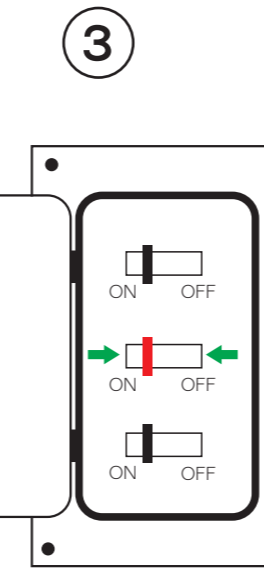

Turn on circuit breaker

Turn on your switch's power from the circuit breaker.

Welcome to the atomi smart family!

We know you will love our products so much that we are giving you an exclusive **15% off your next purchase on atomismart.com.**

Log onto <https://atomismart.com/shop-now/>

Add to Cart

Enter promo code **ATOMI15OFF**

Proceed to checkout

Free shipping on orders over \$50
within the contiguous US only

Terms and conditions apply.

The following terms and conditions apply to the promo code:
1. Coupon is only valid on the atomi smart website www.atomismart.com.
2. A valid code must be entered at the checkout page in order to redeem the promotion.
3. Customers can only redeem one time at checkout.
4. Customers can only use the promo code once.
5. atomi smart reserves the right to cancel or modify any order, or revoke the use of the promo code for any reason.
6. Unless otherwise stated, promo codes are not valid in conjunction with other promotions or discounts.
7. Additional terms and conditions may be specified in relation to specific promo code (for example, duration, eligibility, discount amount and products covered), and will govern the use and redemption of those vouchers.
8. Promo code is not exchangeable for cash.
9. atomi smart will not be liable and/or be required to offer replacement codes, discounts, credits, cash or otherwise compensate customers for:
a. discontinued or cancelled promo code;
b. improper use of, or inability to redeem, a promo code; or
c. the inability to redeem promo code due to technical issues.

FCC Notice:
This device complies with Part 15 of the FCC Rules. Operation is subject to the two following conditions:
1. This device may not cause harmful interference.
2. This device must accept any interference received, including interference that may cause undesired operation.

Note:
This equipment has been tested and found to comply with the limits for a Class B digital device, pursuant to Part 15 of the FCC Rules. These limits are designed to provide reasonable protection against harmful interference in a residential installation.

Warning
This product can expose you to chemicals including Lead, which is known to the State of California to cause birth defects or other reproductive harm. For more information go to www.P65Warnings.ca.gov.

atomismart
For questions or concerns, email us at support@atomiusa.com
Manufactured and marketed by Atomi Inc.
10 West 33rd St., New York, NY 10001
atomismart is a trademark of Atomi Inc.
atomismart is a registered trademark of Atomi Inc.
Designed by atomi in New York. Made in China.

Five-year limited warranty from the date of purchase against defects in material and workmanship.