



Let's get started!

Smart WiFi Ceramic Tower Heater

Quick Start Guide

IMPORTANT SAFEGUARDS

TO AVOID THE RISK OF AN ELECTRICAL SHOCK, always make sure that the Smart Heater is unplugged from the electrical outlet before relocating, servicing, or cleaning it.

CAUTION: To prevent an electric shock, match wide blade of plug to wide outlet slot and fully insert.

When using electrical appliances, basic safety precautions should always be followed to reduce the risk of fire, electric shock, and/or injury to people, including the following:

1. READ ALL INSTRUCTIONS BEFORE USING.
2. The Smart Heater is hot when in use. To avoid burns, do not let bare skin touch the hot surfaces. Use the back handle of the heater when moving. Keep combustible materials such as furniture, pillows, bedding, papers, clothes, and curtains at least three feet (0.9 m) away from the front of the heater and keep them away from the sides and rear.
3. Extreme caution is necessary when the heater is being used by or near children and whenever the heater is left operating and unattended.
4. Do not operate if the cord or plug has been damaged, if the heater malfunctions, or if it has been dropped or damaged in any manner.
5. Do not use outdoors.
6. The Smart Heater is not intended for use in bathrooms, laundry areas, nor similar indoor locations. Never place the heater where it may fall into a bathtub or water container.
7. Do not run the cord under carpeting. Do not cover the cord under throw rugs, runners, or similar coverings. Do not route the cord under furniture or appliances. Arrange the cord away from high-traffic areas where it could be tripped over.
8. To disconnect the Smart Heater, turn controls to "Off", then remove the plug from the outlet.
9. Connect to standard outlets only.
10. Do not insert or allow foreign objects to enter any ventilation or exhaust as this may result in an electric shock or fire. It may also damage the Smart Heater.
11. To prevent possible fire, do not block air intakes or exhaust in any manner. Do not use on soft surfaces like a bed where openings may be blocked.

12. The Smart Heater has hot and arcing or sparking parts inside. Do not use it in areas where gasoline, paint, or flammable liquids are used or stored.
13. Use this Smart Heater only as described in this user manual. Any other use not recommended by the manufacturer may cause fire, electric shock, or injury to people.
14. Always plug the Smart Heater directly into a wall outlet/receptacle. Never use it with an extension cord or relocatable power tap (outlet/power strip).

NOTE: This appliance is for HOUSEHOLD USE ONLY.

ELECTRIC POWER
If the electric circuit is overloaded by other appliances, your Smart Heater and/or appliances may not operate properly. The Smart Heater should be operated on a separate electrical circuit from other operating appliances.

POLARIZED PLUG
This Smart Heater has a polarized plug (one blade is wider than the other). As a safety feature to reduce the risk of electrical shock, this plug is intended to fit in a polarized outlet only one way. If the plug does not fully insert into the outlet, try reversing plug.

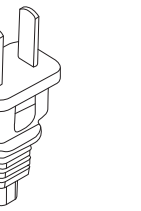

Before you begin

1. Remove tie from the power cord and unravel the cord. Keep the plastic wrapping away from children.
2. Place the Smart WiFi Ceramic Tower Heater on the floor in the desired location.
3. Know your Wi-Fi network and password.
4. Make sure that you are operating on:
 - iPhone® 8 or higher and iOS® 8 or higher.
 - Any previous iPhone® or iOS® may experience slower connections.
 - Android™ 4.1x or higher.
5. Make sure that you're connected to a 2.4GHz Wi-Fi network (Atomi Smart app can't connect to 5GHz networks).

List of main parts

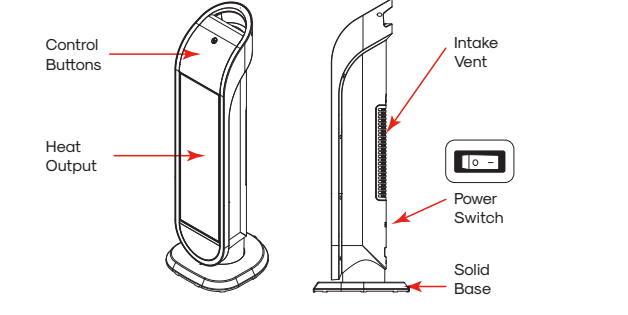

Control Buttons

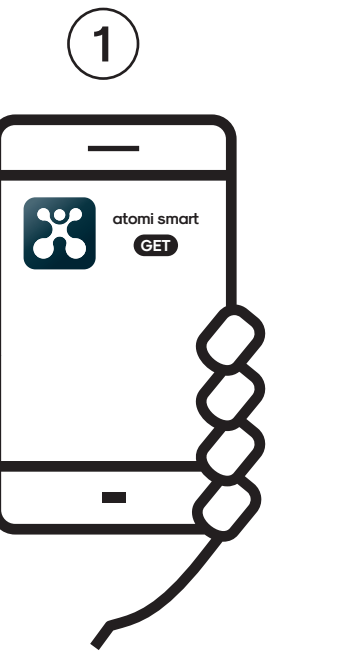
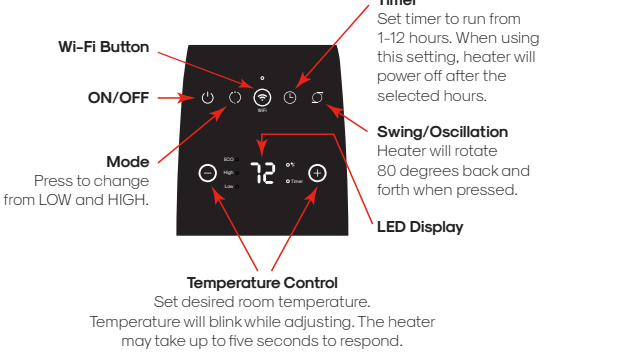

Get the app

Download the Atomi Smart app from the App Store or Google Play.



Register

Follow the on-screen instructions and register an account.

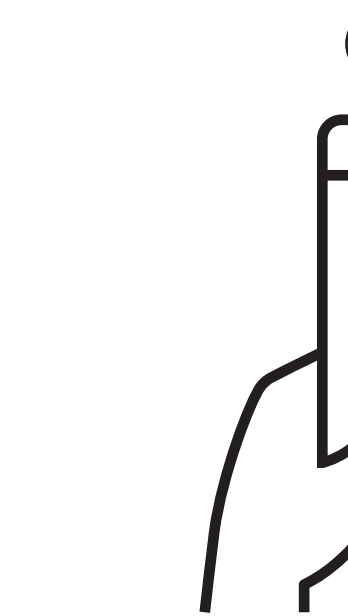

Add your smart device

Press "Add Device" or the "+" sign and choose the smart device to install from the device list.

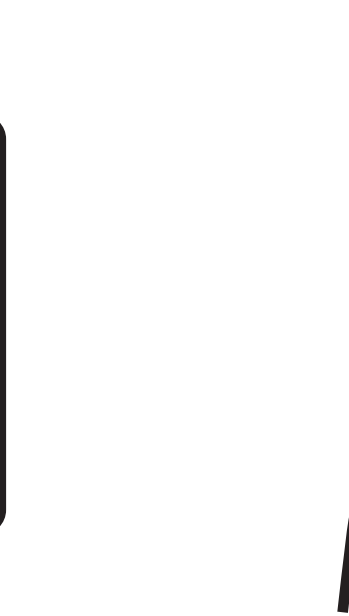

Select the right network

Enter your WiFi password and "Confirm".
Make sure you're connected to a 2.4GHz WiFi network (atomi Smart can't connect to 5GHz networks).

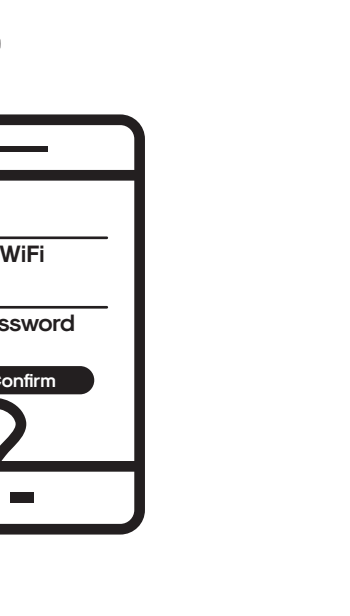

Plug in your smart device

Use the switch on the back to turn it on and press "Continue" on the Atomi Smart app.

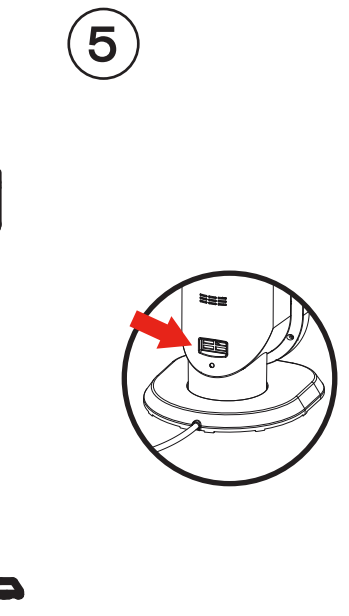

Connect to the network

Press "Go to Connect" and follow the instructions on the screen.

7



Connect your smart device

Select "atomi-smart-XXXX" on the network list to connect.

If you are not automatically directed to the WiFi list, go to SETTINGS on your smartphone and press WiFi.

Troubleshooting

Smart WiFi Ceramic Tower Heater

I can't find the atomi.smart.XXXX network in my WiFi list.

Make sure your Atomi Smart device is plugged in and the WiFi light is blinking quickly. If not, unplug your Atomi Smart device and plug it back in to reboot.

My WiFi network doesn't appear in the Atomi Smart app.

Use your smartphone to confirm that you have at least two WiFi bars in the vicinity of your Atomi Smart device. If not, move your Atomi Smart device closer to your router. (The list will refresh every 10 seconds).

Cannot connect to my WiFi network.

Make sure that you have entered the correct WiFi password during the WiFi setup. Check if there are problems with your internet connection. If the WiFi signal is too weak, reset your WiFi router and try again.

My Atomi Smart device appears as "Unavailable" in the app.

Refresh the device list.

My Atomi Smart app is frozen.

Force quit and re-launch the Atomi Smart app.

I just replaced my router.

To reset the WiFi without losing your Atomi Smart devices settings, hold down the power button and wait for the LED to change from amber to blinking white, then release.

When the LED begins to alternate white and amber, follow steps 3-5 to associate your Atomi Smart device with your new network.

I'm still having trouble!

WiFi networks come in a lot of shapes and sizes with many quirks of their own. It doesn't mean your Atomi Smart device is malfunctioning. If problems persist, please try these steps, in this order:

1. Force quit and re-launch the Atomi Smart app. Check to see if this fixes the issue.
2. Unplug your Atomi Smart device and plug it back in. Check to see if this fixes the issue.
3. Unplug your router and plug it back in. Check to see if this fixes the issue.
4. Delete and reinstall the Atomi Smart app. Check to see if this fixes the issue.

For more troubleshooting tips go to www.atomismart.com/helpHeater

Turning Off the Smart Heater

Use the ON/OFF button or the power switch on the Atomi Smart app to turn off your heater.
NOTE: The LED display will stay illuminated and count down from 6 seconds before turning off.

Cleaning and Maintaining Your Smart Heater

CAUTION: Always be sure the Smart Heater is switched OFF, unplugged and completely cooled before cleaning or attempting to store the item. DO NOT immerse Smart Heater in water or allow water to drip into the interior of the Smart Heater, as this could create an electric shock hazard. DO NOT use any detergents or abrasives.

Care and Cleaning

1. Always turn off the Smart Heater and disconnect the cord from the electrical outlet before cleaning your heater.
2. Accumulated dust may be removed from the Smart Heater with a soft cloth or vacuum cleaner.
3. Ensure the air intake vent on the back of Smart Heater is free and clear of dust or lint.
4. The removable particle filter should be cleaned and dried out at least 1-2 times per season. Remove the air intake vent cover and hand wash the particle filter with soap and water.
5. Clean the outside of the heater by wiping it with a damp cloth and buff with a dry cloth.

Storing

Allow the Smart Heater to cool completely before storing. Store in a dry location. Do not place heavy items on top of the Smart Heater as this may result in possible damage.

Still can't connect? Need assistance?

Our friendly customer service team will work hard to put a smile back on your face. Here's how we can connect.



1-800-757-1440
Mon-Fri 9:00-5:00 EST (US)



or support@atomiusa.com

Welcome to the Atomi Smart family!

We know you will love our products so much that we are giving you an exclusive **15% off** your next purchase on atomismart.com.



Log onto <https://atomismart.com/shop-now/>



Add to Cart



Enter promo code **ATOMI15OFF**



Proceed to checkout



Free shipping on orders over \$50
within the contiguous US only

Terms and conditions apply.

- The following terms and conditions apply to the promo code:
1. Coupon is only valid on the Atomi Smart website www.atomismart.com.
 2. A valid code must be entered at the checkout page in order to redeem the promotion.
 3. Customers can only redeem one time at checkout.
 4. Customers can only use the promo code once.
 5. Atomi Smart reserves the right to cancel or modify any order, or revoke the use of the promo code for any reason.
 6. Unless otherwise stated, promo codes are not valid in conjunction with other promotions or discounts.
 7. Additional terms and conditions may be specified in relation to specific promo code (for example, duration, eligibility, discount amount and products covered), and will govern the use and redemption of those vouchers.
 8. Promo code is not exchangeable for cash.
 9. Atomi Smart will not be liable and/or be required to offer replacement codes, discounts, credits, cash or otherwise compensate customers for:
 - a. discontinued or cancelled promo code;
 - b. improper use of, or inability to redeem, a promo code; or
 - c. the inability to redeem promo code due to technical issues.

FCC Notice:

This device complies with Part 15 of the FCC Rules. Operation is subject to the two following conditions:
1. This device may not cause harmful interference.
2. This device must accept any interference received, including interference that may cause undesired operation.

Note:

This equipment has been tested and found to comply with the limits for a Class B digital device, pursuant to part 15 of the FCC Rules. These limits are designed to provide reasonable protection against harmful interference in a residential installation. This equipment generates, uses, and can radiate radio frequency energy and, if not installed and used in accordance with the instructions, may cause harmful interference to radio communications. However, there is no guarantee that interference will not occur in a particular installation. If this equipment does cause harmful interference to radio or television reception, which can be determined by turning the equipment off and on, the user is encouraged to try to correct the interference by one or more of the following measures:
- Reorient or relocate the receiving antenna.
- Increase the separation between the equipment and receiver.
- Connect the equipment into an outlet on a circuit different from that to which the receiver is connected.
- Consult the dealer or an experienced radio/TV technician for help.

Note:

Changes or modifications not expressly approved by the party responsible for compliance could void the user's authority to operate this device.

Warning

This product can expose you to chemicals including Lead, which is known to the State of California to cause birth defects or other reproductive harm. For more information, go to www.P65Warnings.ca.gov.



For questions or concerns, email us at support@atomiusa.com
Manufactured and marketed by Atomi Inc.
10 West 33rd St., New York, NY 10001
atomi™ is a trademark of Atomi Inc.
Atomi Smart® is a registered trademark of Atomi Inc.
Designed by atomi in New York. Made in China.

Three-year limited warranty from the date of purchase against defects in material and workmanship.